

ALDEA INTEGRAL DE SALUD Y BIENESTAR

Arquitectura para promover la salud y la prevención



CAPILLA DEL MONTE, CÓRDOBA.

BERTOIGNA - PEREZ

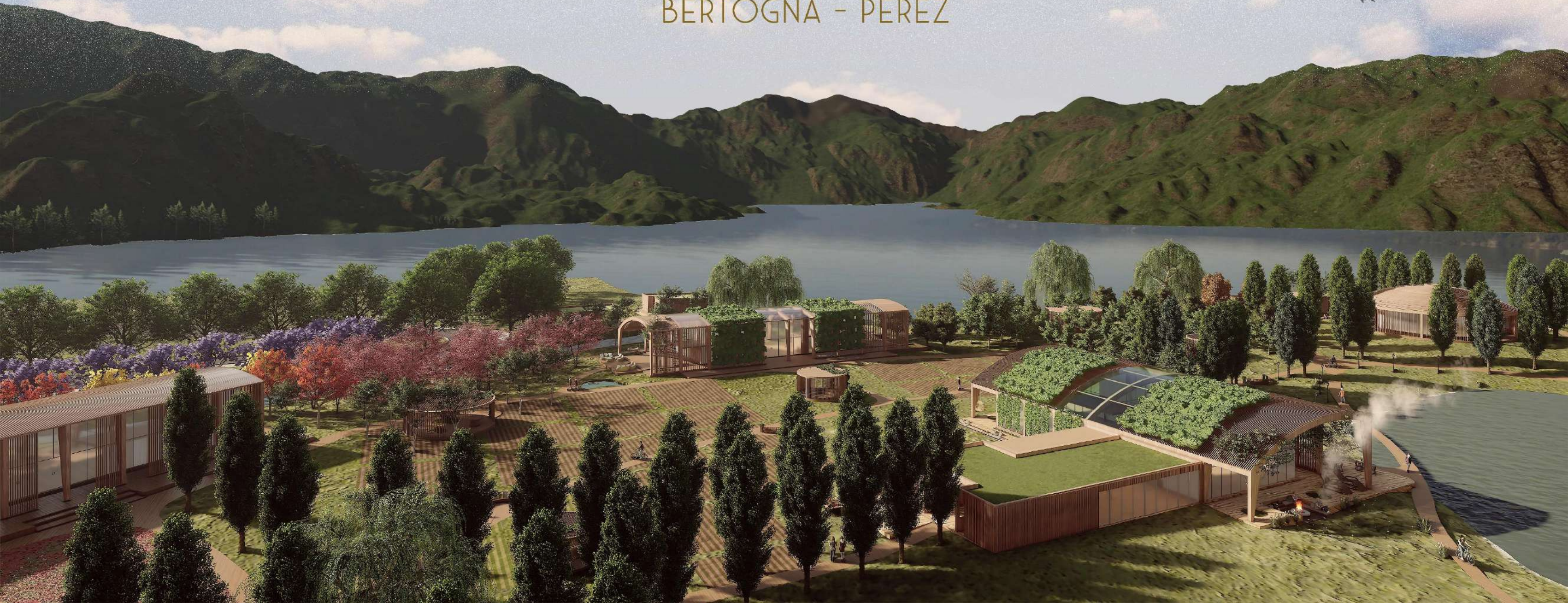



PREDICTIVA

PREVENTIVA

PARTICIPATIVA

PERSONALIZADA

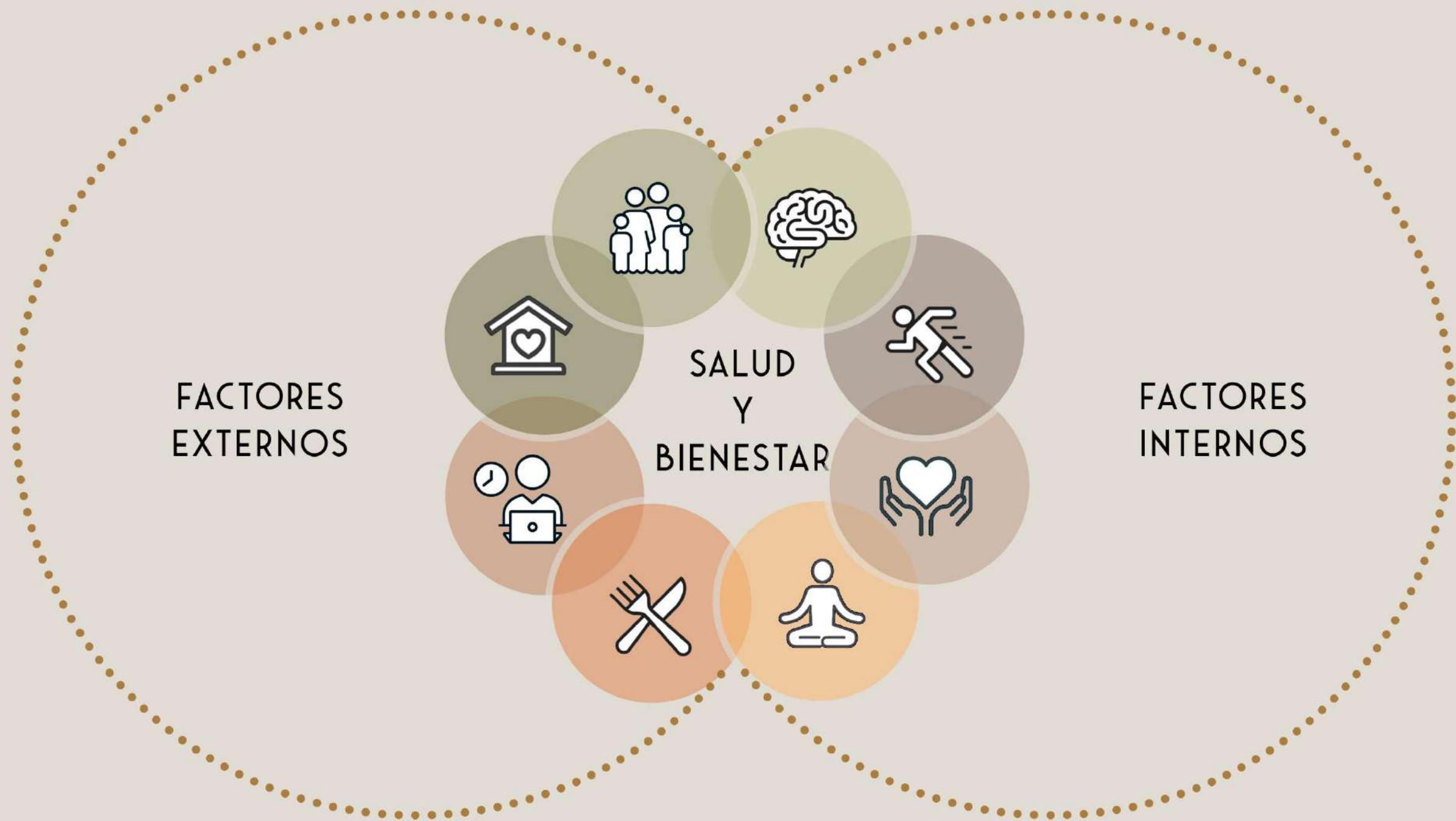

FACTORES
EXTERNOS

SALUD
Y
BIENESTAR

FACTORES
INTERNOS

USUARIOS

Adolescentes y jóvenes con
desordenes alimenticios





COVID-19

↑ 40%

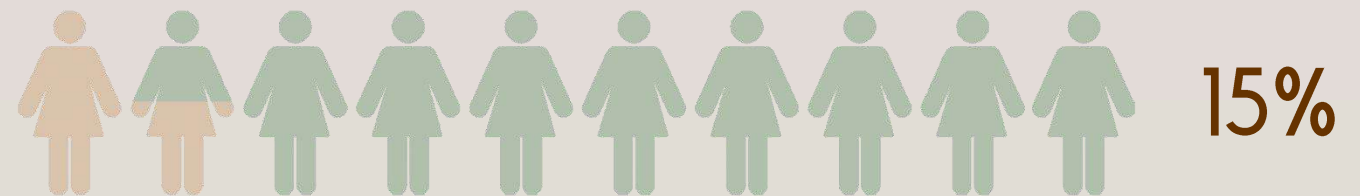



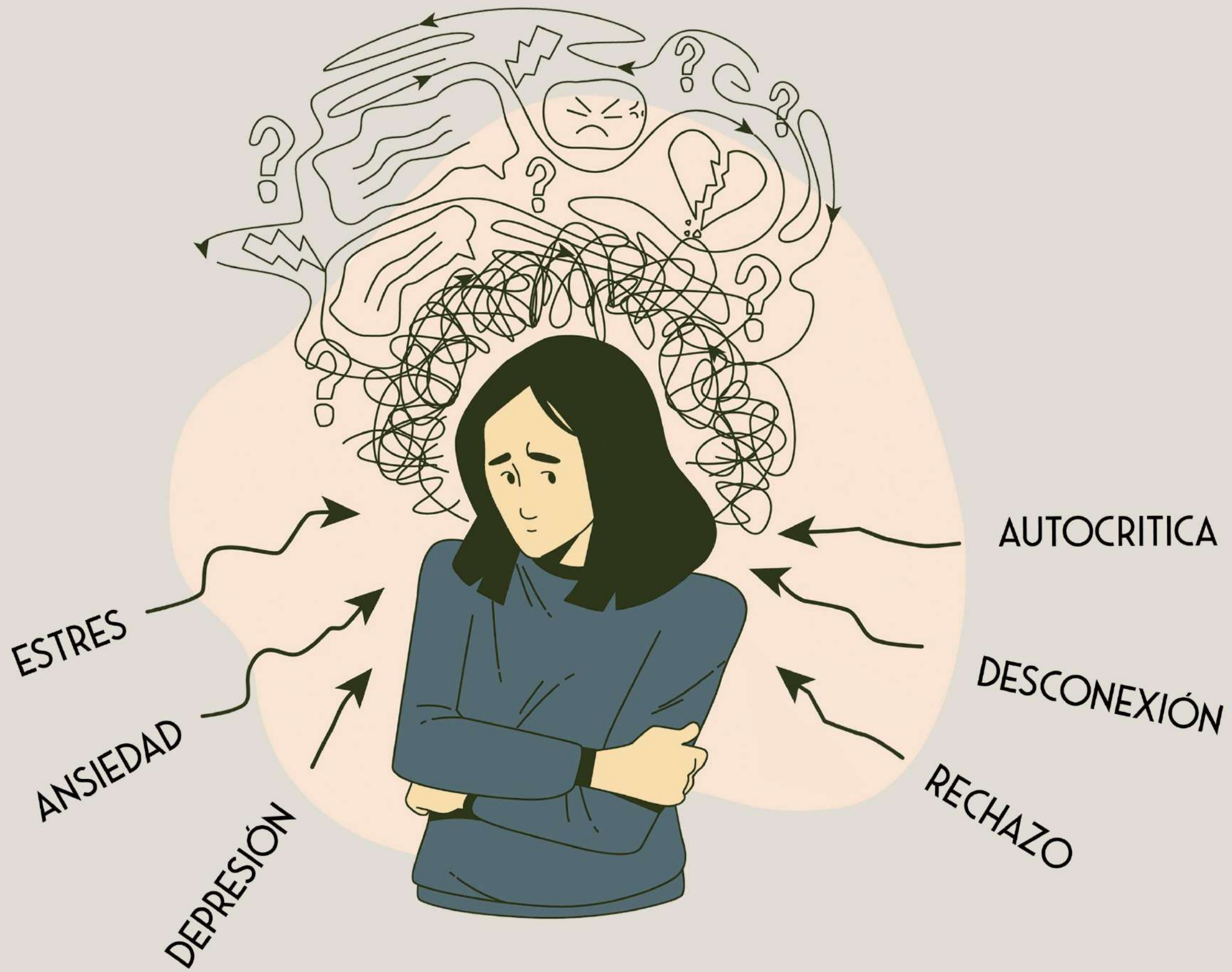

» EL PROYECTO BUSCA RE-EDUCAR Y CONCIENTIZAR EN EL TRATAMIENTO «



UBICACIÓN

● Republica Argentina



● Provincia de Còrdoba



● Valle de Punilla

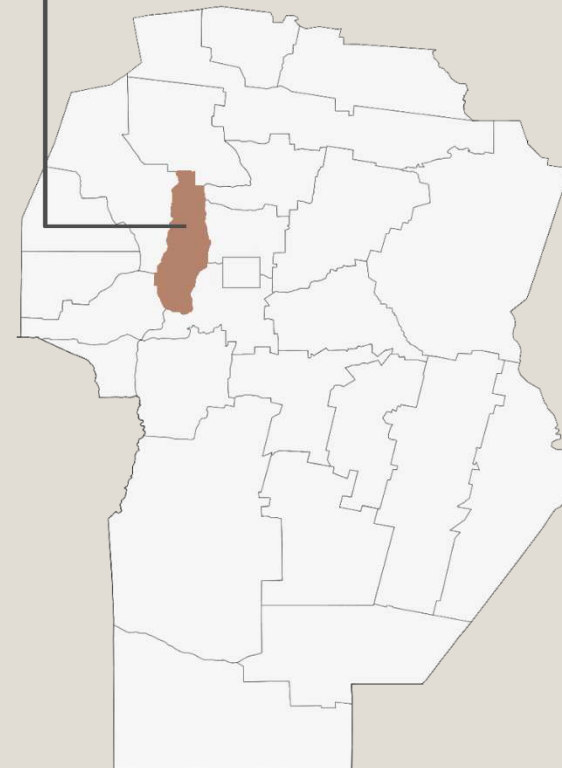

● Capilla del Monte

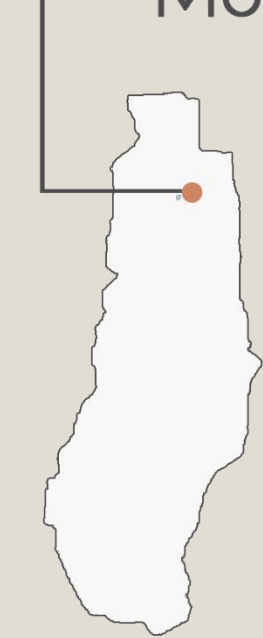



SISTEMA DE TRANSPORTE ACCESIBLE Y PÚBLICO



RED HOSPITALARIA CONEXIÓN RED DE SALUD

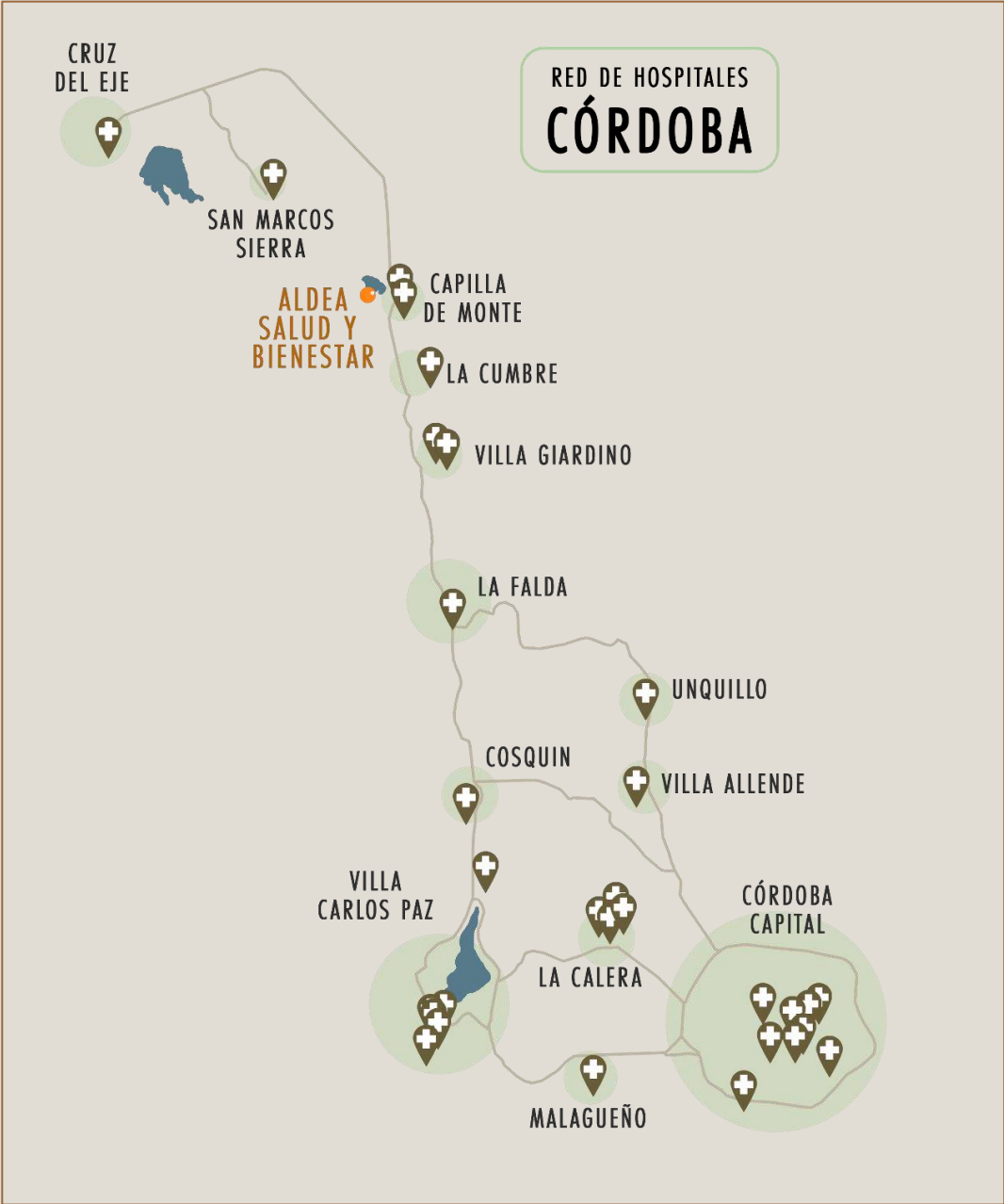



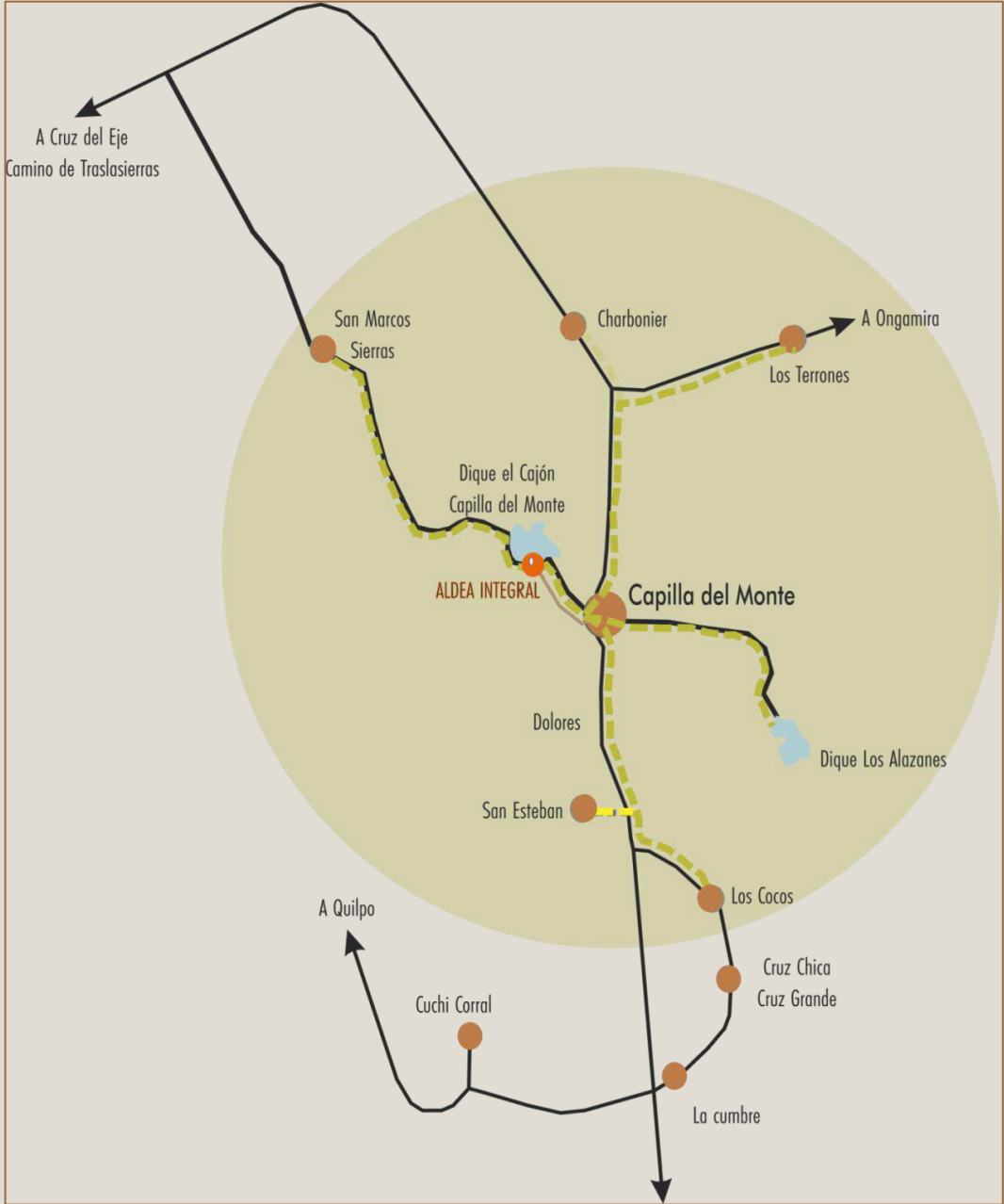

MOVILIDAD SUSTENTABLE 15KM







CAPILLA DEL MONTE



EQUIPAMIENTOS

-  TERMINAL DE OMNIBUS
-  HOSPITALES Y CLINICAS
-  ESTACIÓN DE TRENES
-  CALLE TECHADA

-  ACTIVIDADES DE BIENESTAR
 - REIKI
 - YOGA
 - MEDITACIÓN
 - SONIDOTERAPIA
 - MEDICINA CHINA
 - MASOTERAPIA
 - PSICOMOTRICISMO

-  RUTA NACIONAL
-  VIAS PRINCIPALES
-  FERROCARRIL
-  CURSO DE AGUA



RELEVAMIENTO DE SITIO - COSTA DIQUE EL CAJÓN - 6 HECTÁREAS

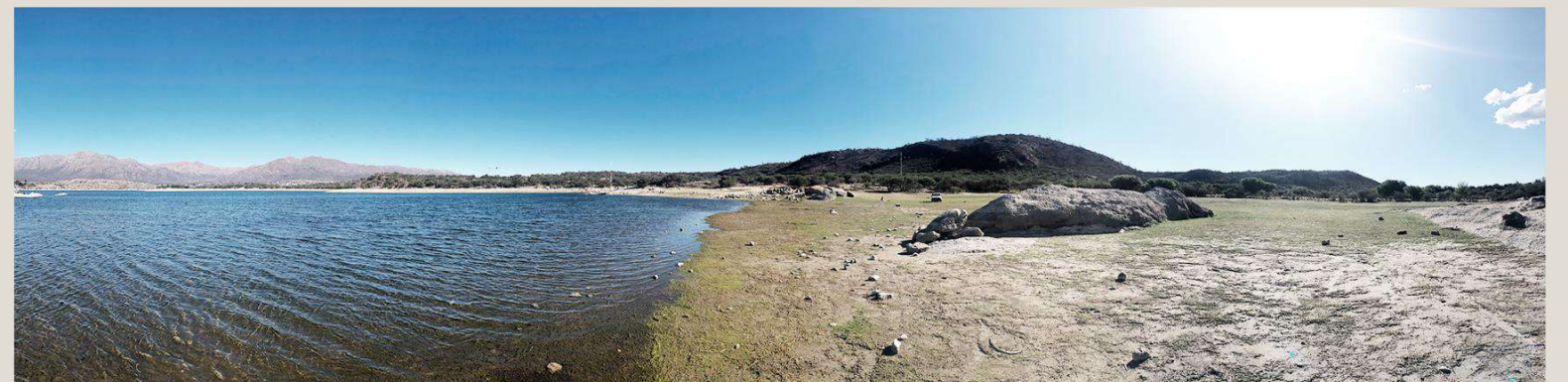

ESCALAS DE PROYECTO

1º - URBANA

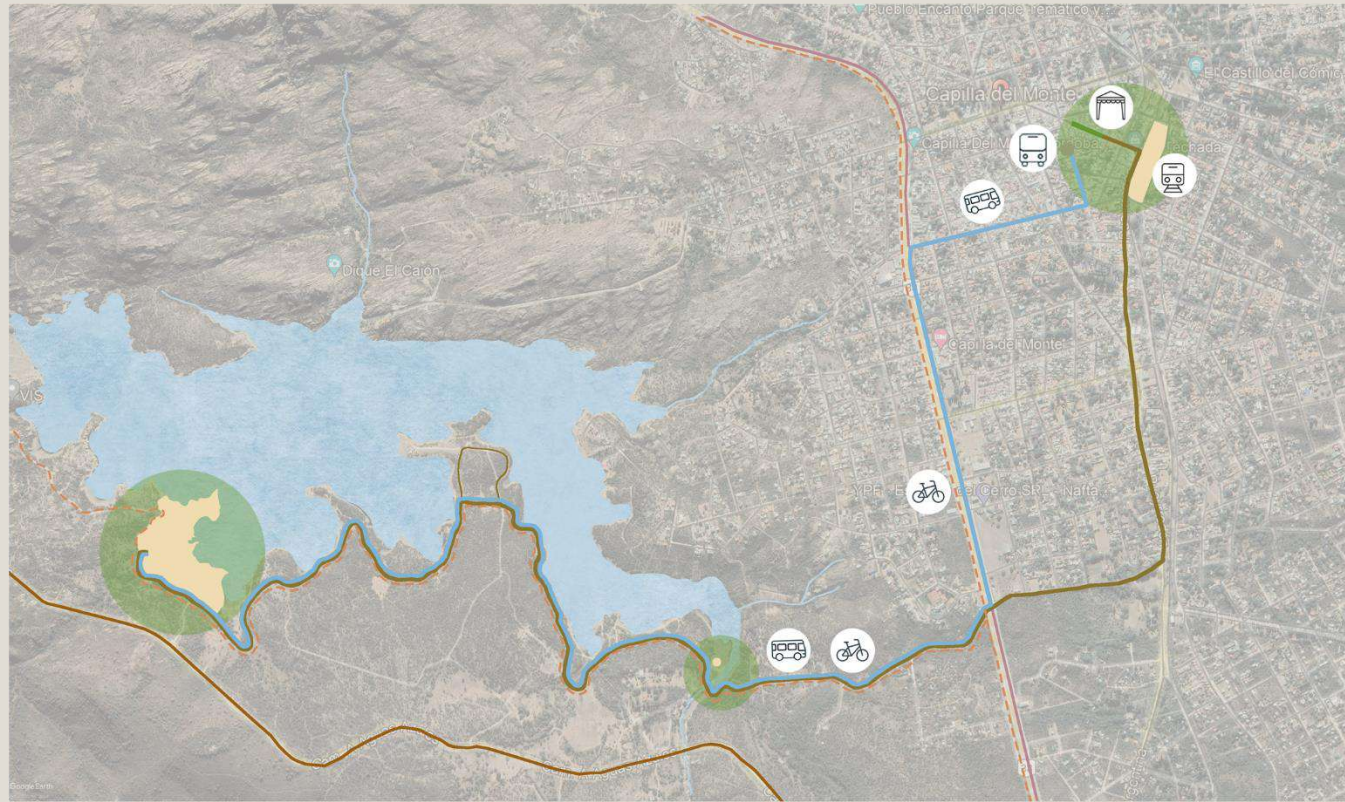

2º - PAISAJE



3º - ARQUITECTURA DEL PAISAJE



4º - ARQUITECTURA

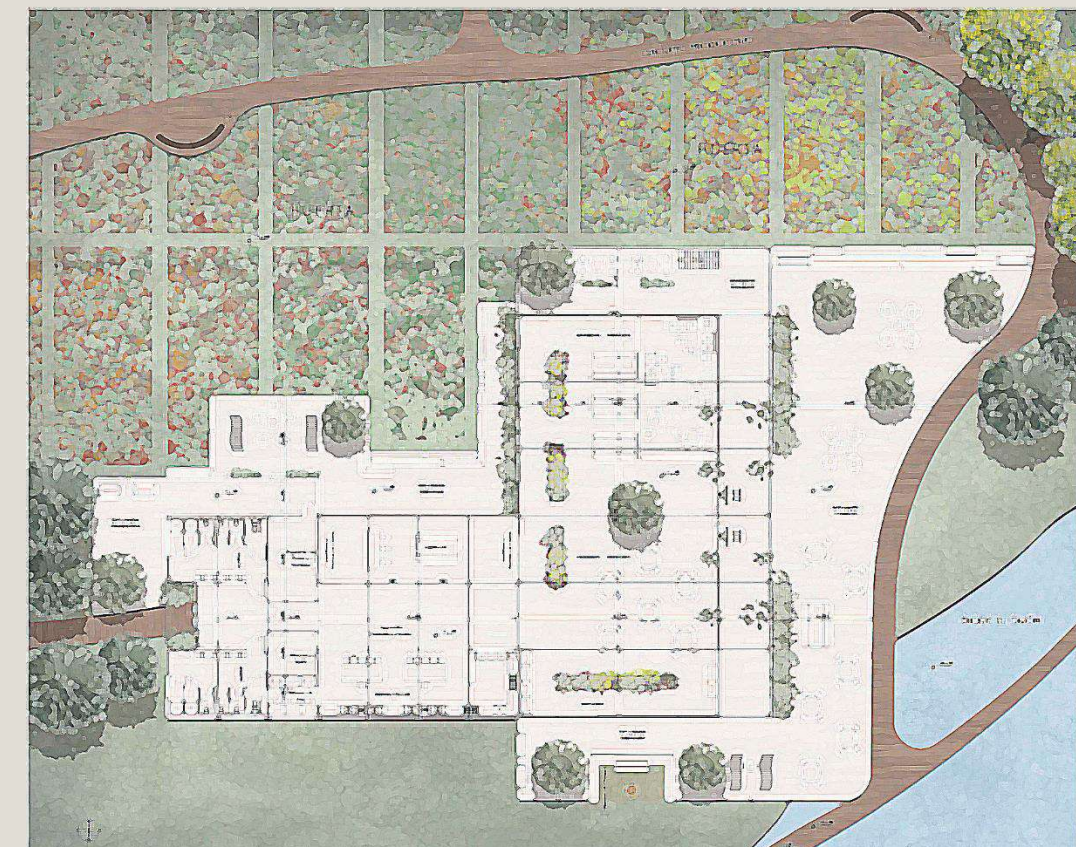

PROPUESTA ESCALA URBANA



CALLE EXISTENTE



RENOVACIÓN VIA E INCORPORACIÓN BICISENDA



CONCEPTUALIZACIÓN

ALDEA



- Arquitectura ligada a la naturaleza.
- Arquitectura de recorrido, fragmentada.
- Comunidad reducida autosuficiente.

ONDULACIÓN SIERRAS



- Formas orgánicas y fluidez especial.
- Expresión curva dada por el cordón serrano.
- Contención.

ESTRUCTURA ESPACIAL

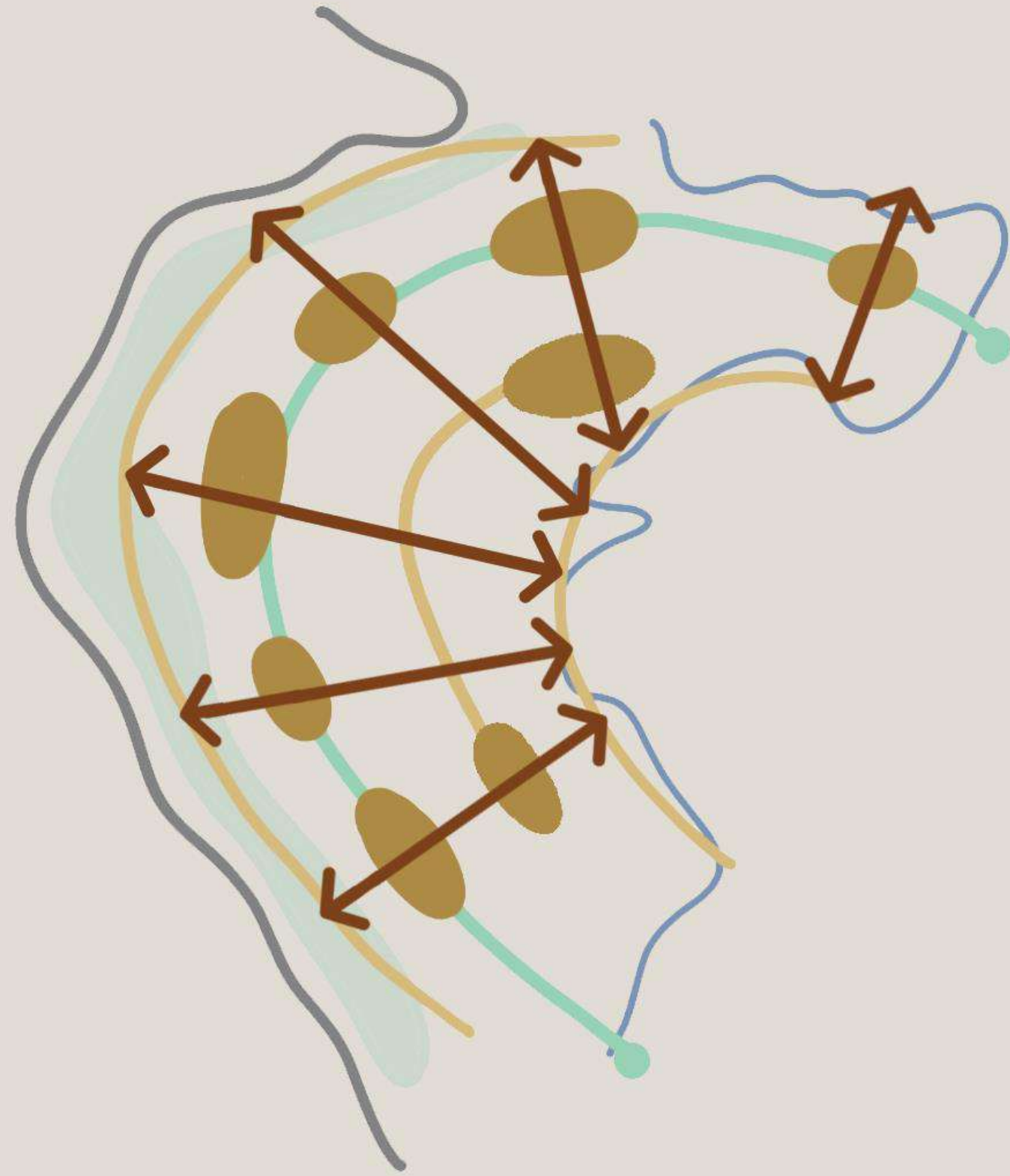

ORGANIZACIÓN ESPACIAL

ESCALA PAISAJISMO

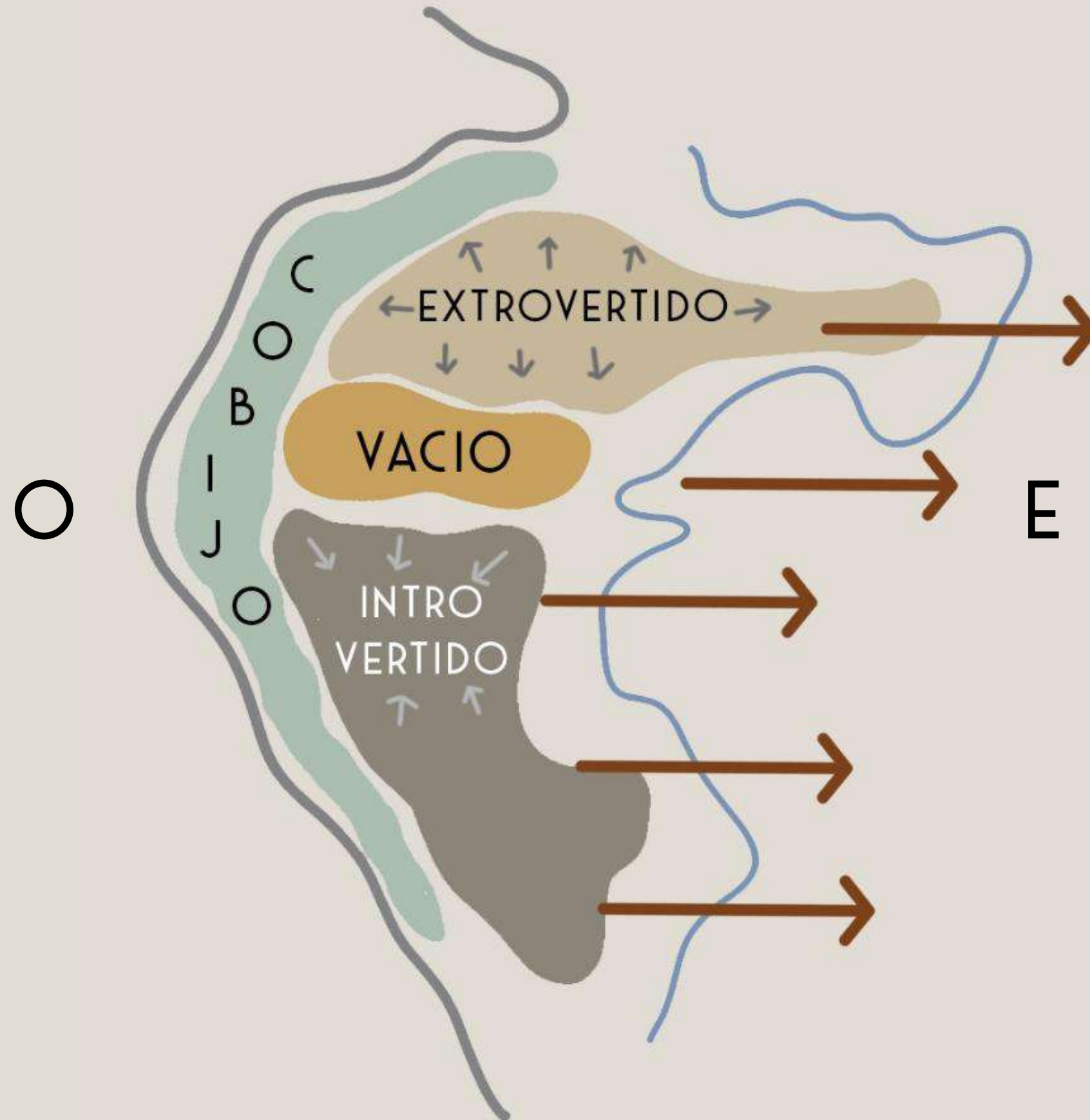

ORGANIZACIÓN ESPACIAL

ESCALA PAISAJE

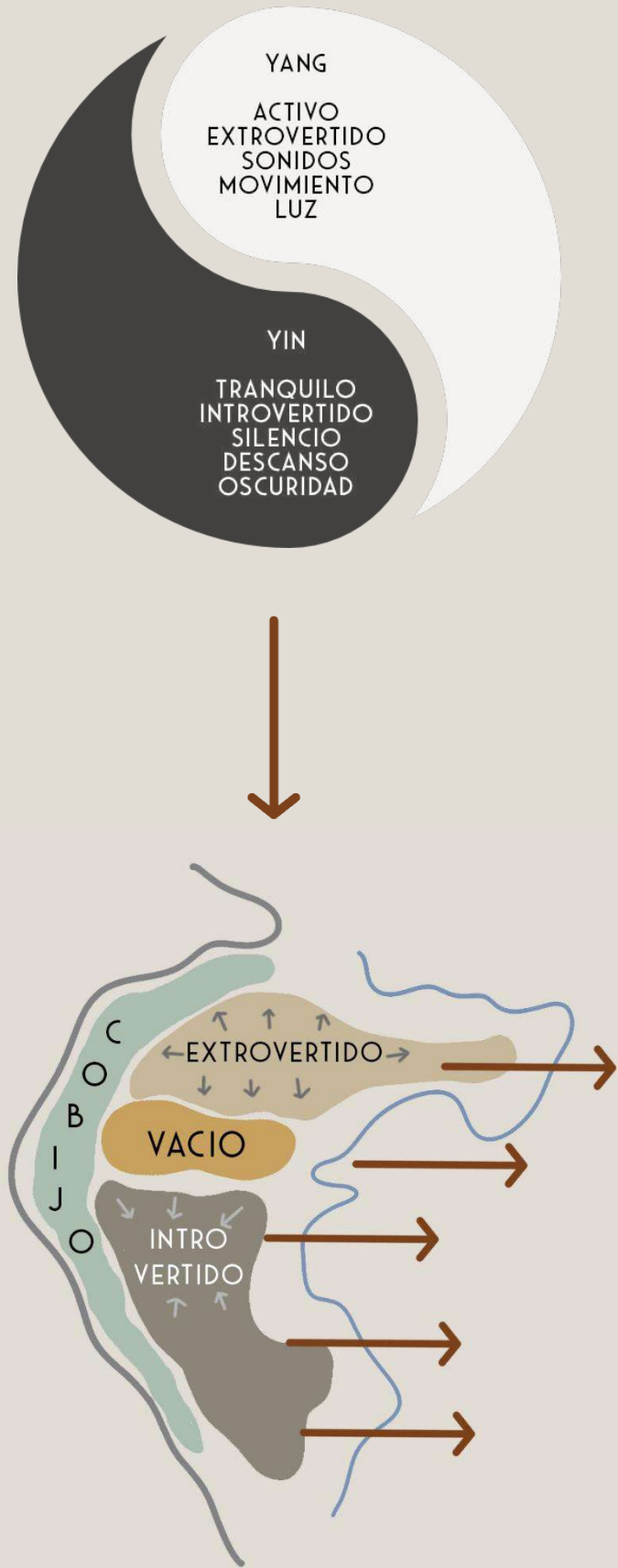

VACÍO CENTRAL DE ENCUENTRO







- TÚNEL VEHICULAR DE PLÁTANOS -

ESCALA ARQUITECTURA DEL PAISAJE

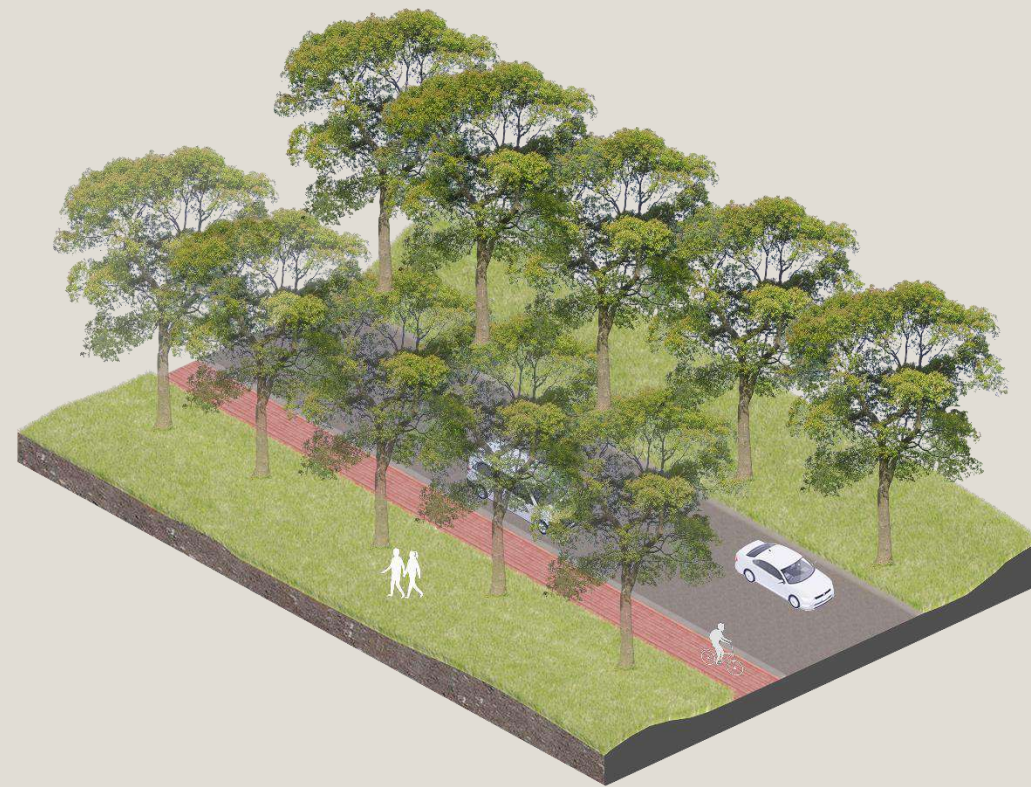

- BOSQUE DE JACARANDA -

ESCALA ARQUITECTURA DEL PAISAJE

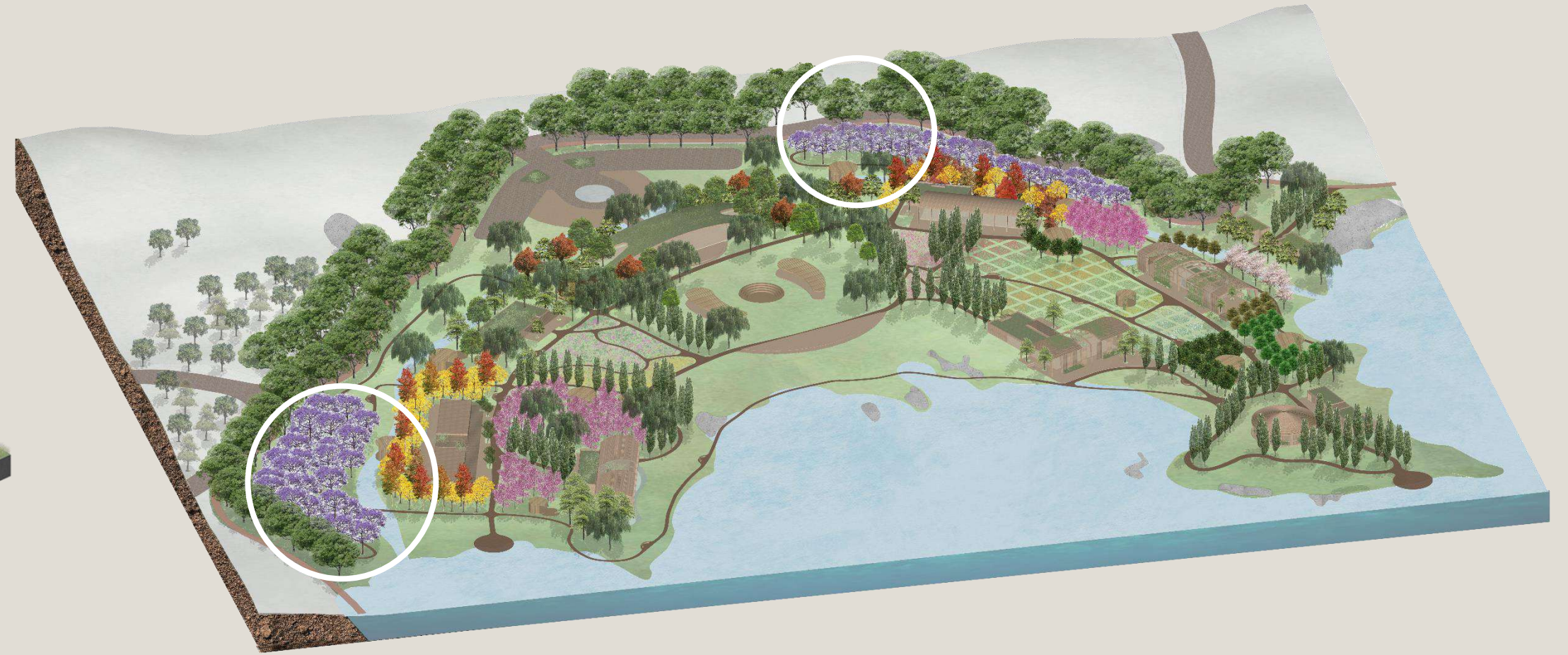

- FRUTALES -

ESCALA ARQUITECTURA DEL PAISAJE

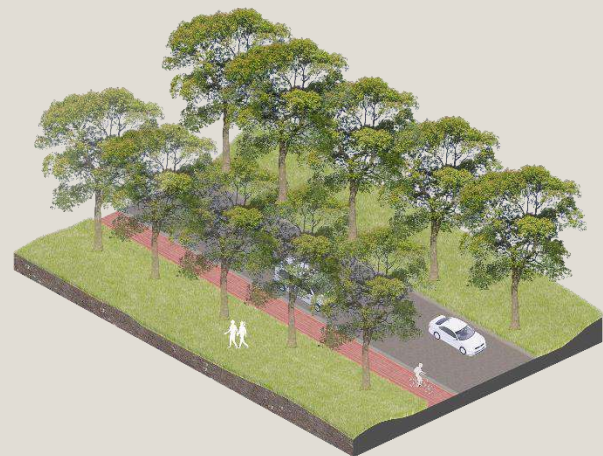

- HUERTA -

ESCALA ARQUITECTURA DEL PAISAJE



- COYUNTURA Y PERMANENCIA EN SAUCE LLORÓN -

ESCALA ARQUITECTURA DEL PAISAJE

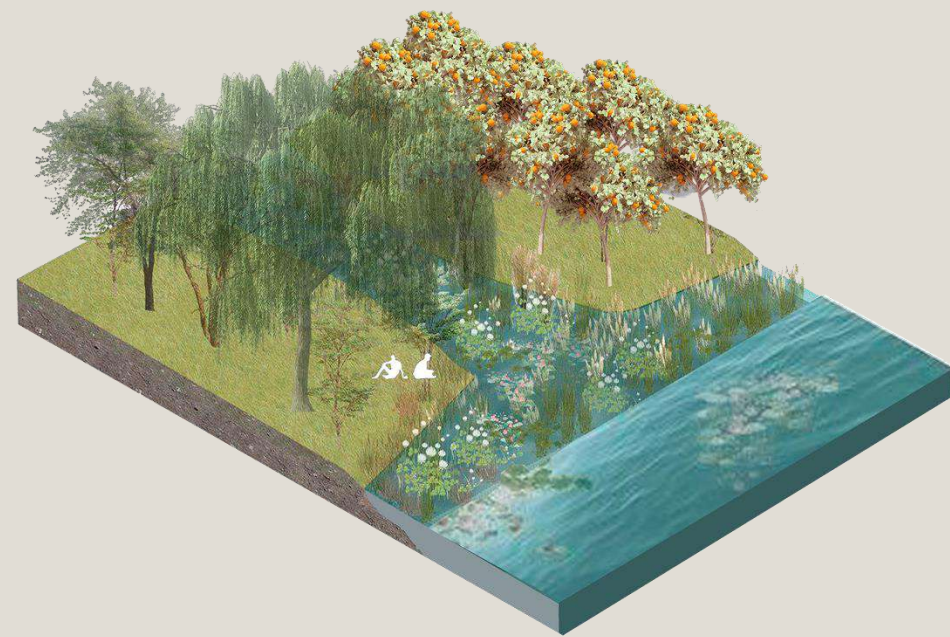

- ÁLAMOS ENMARCANDO CAMINO -

ESCALA ARQUITECTURA DEL PAISAJE

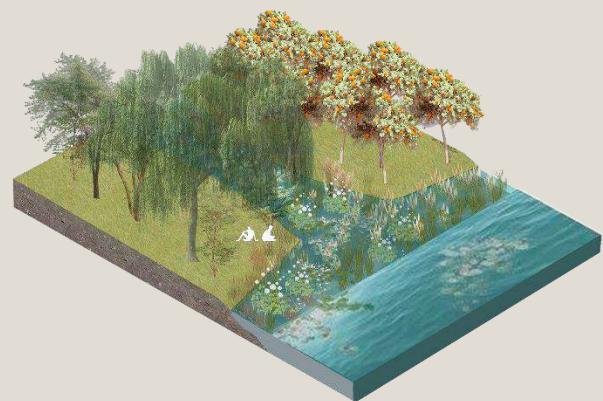
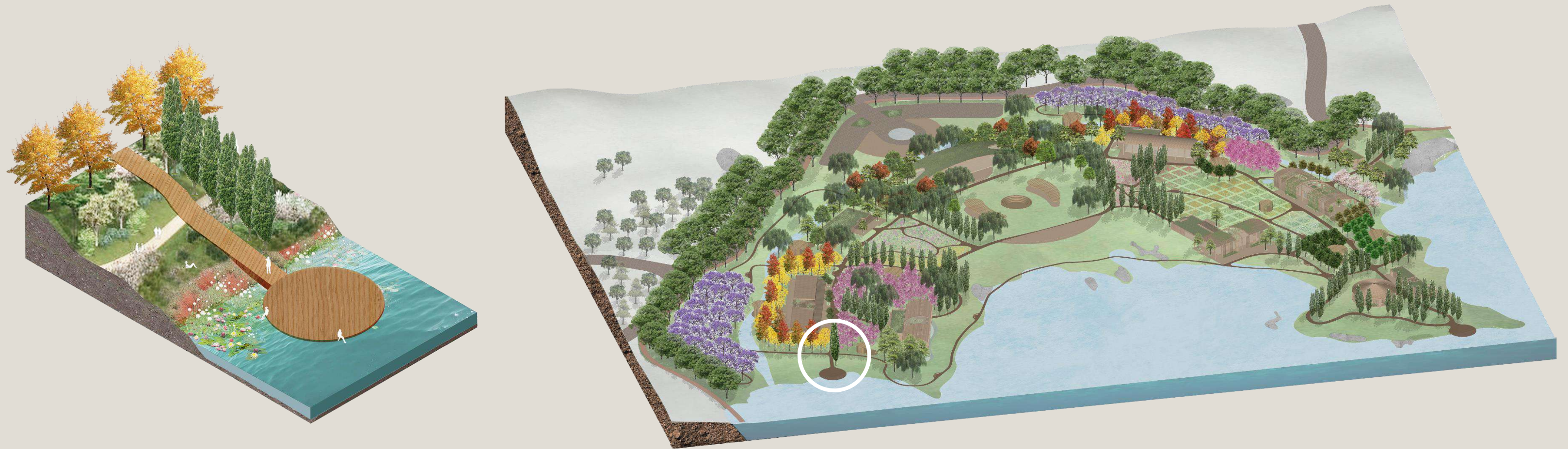

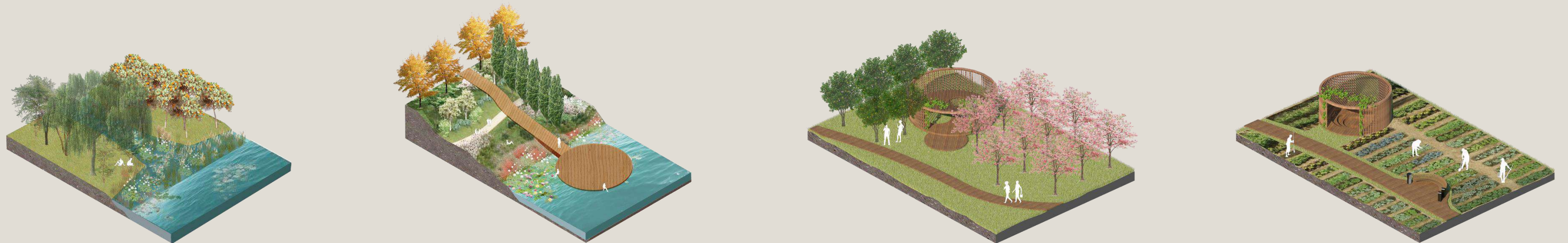
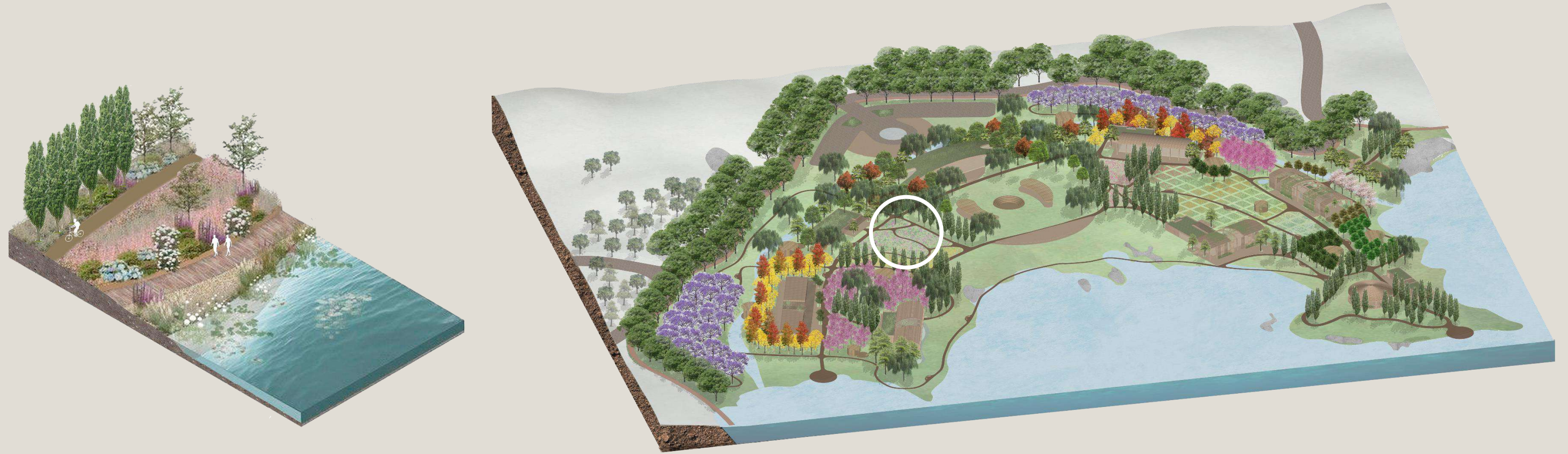

- PLAYA Y BALNEARIO -

ESCALA ARQUITECTURA DEL PAISAJE

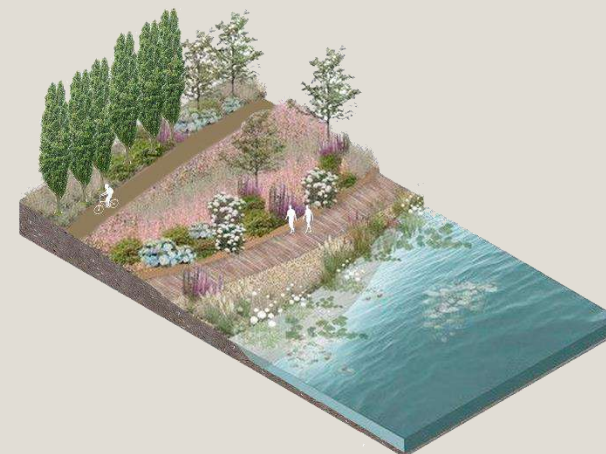
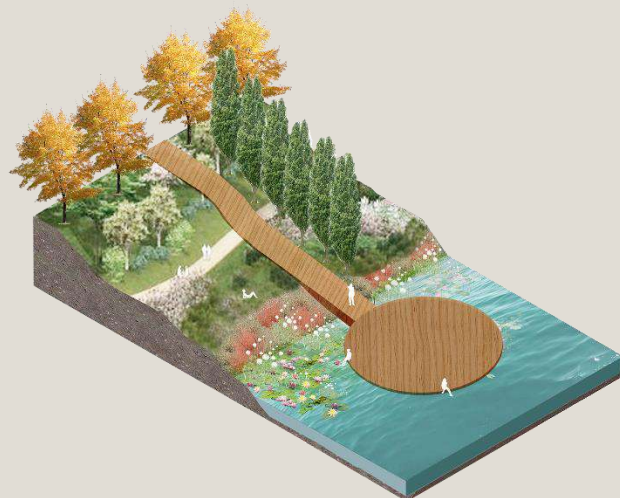
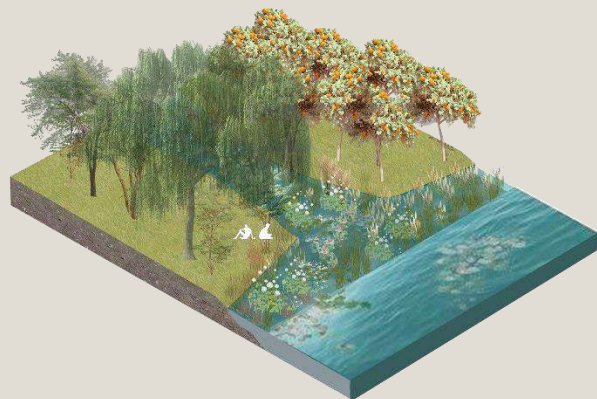
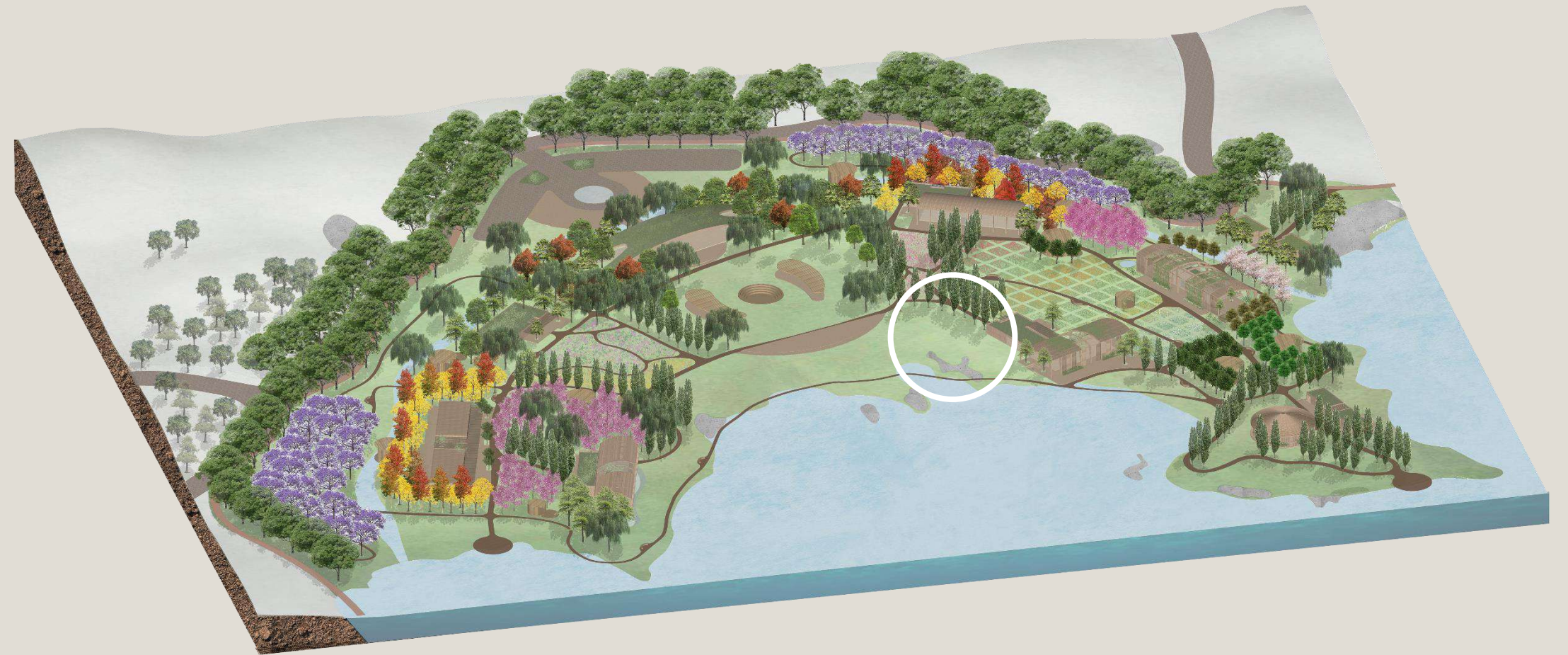
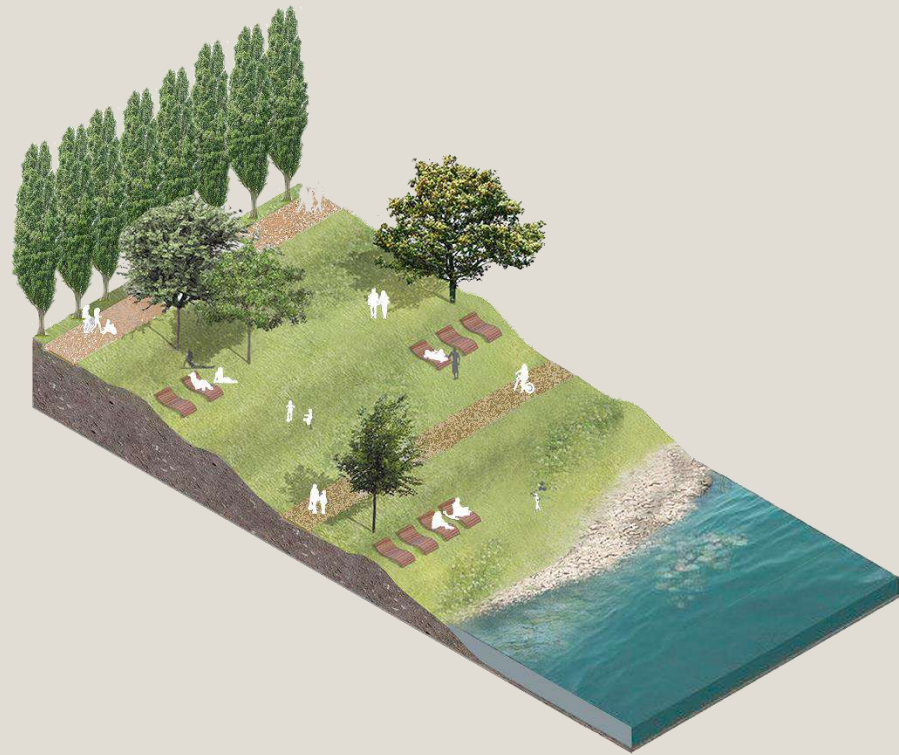

ESCALA ARQUITECTURA DEL PAISAJE

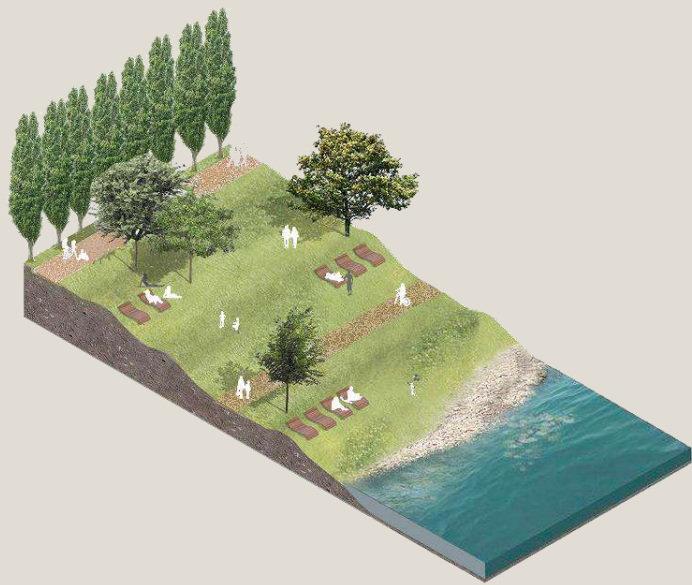
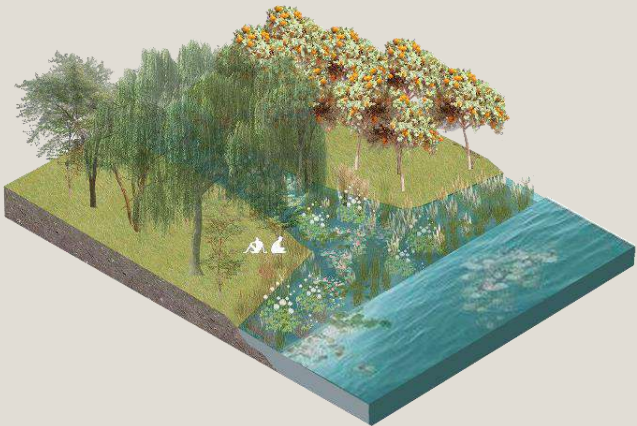

ESCALA ARQUITECTURA DEL PAISAJE



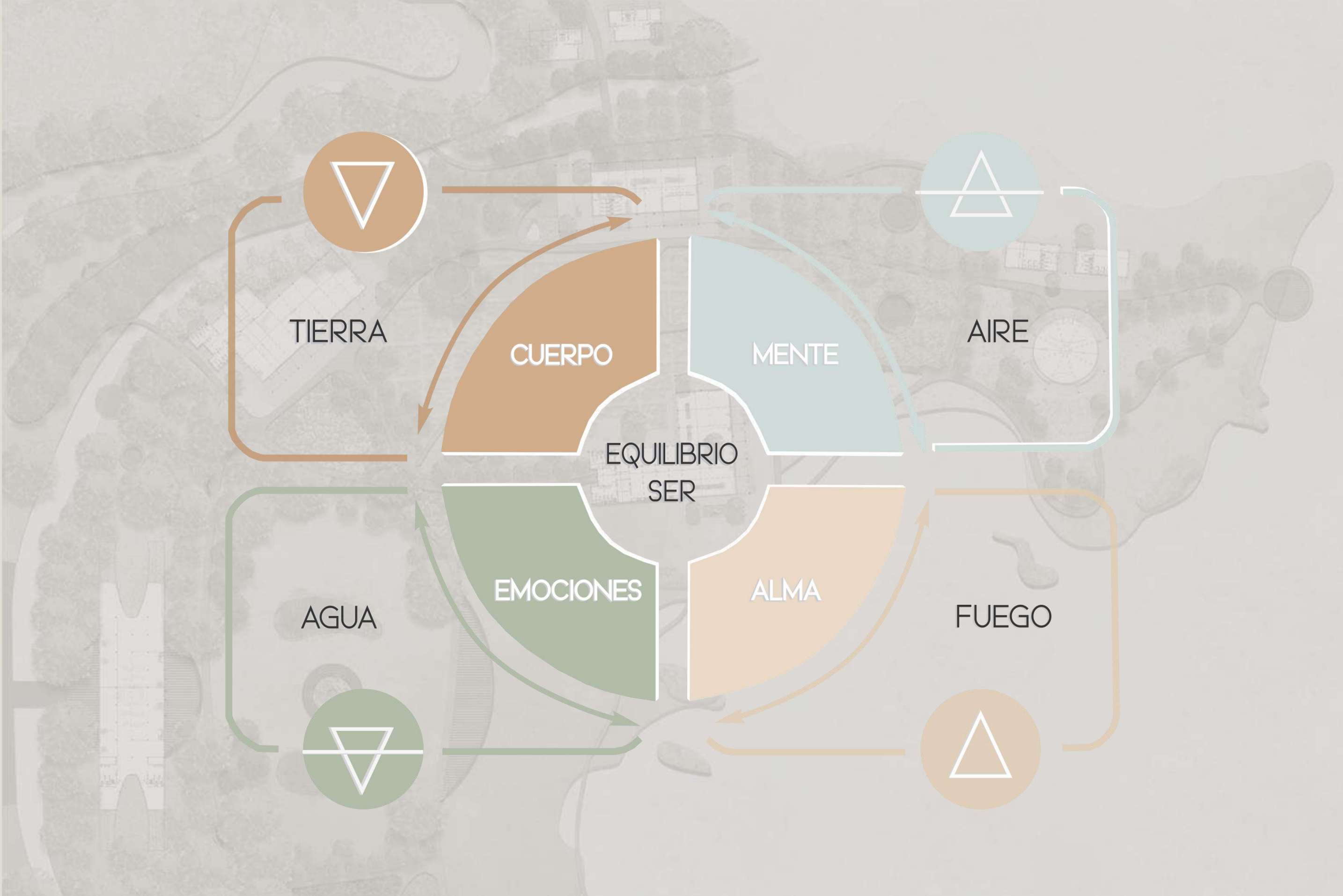

ESCALA ARQUITECTURA DEL PAISAJE



ESCALA ARQUITECTURA DEL PAISAJE



ESCALA ARQUITECTURA DEL PAISAJE

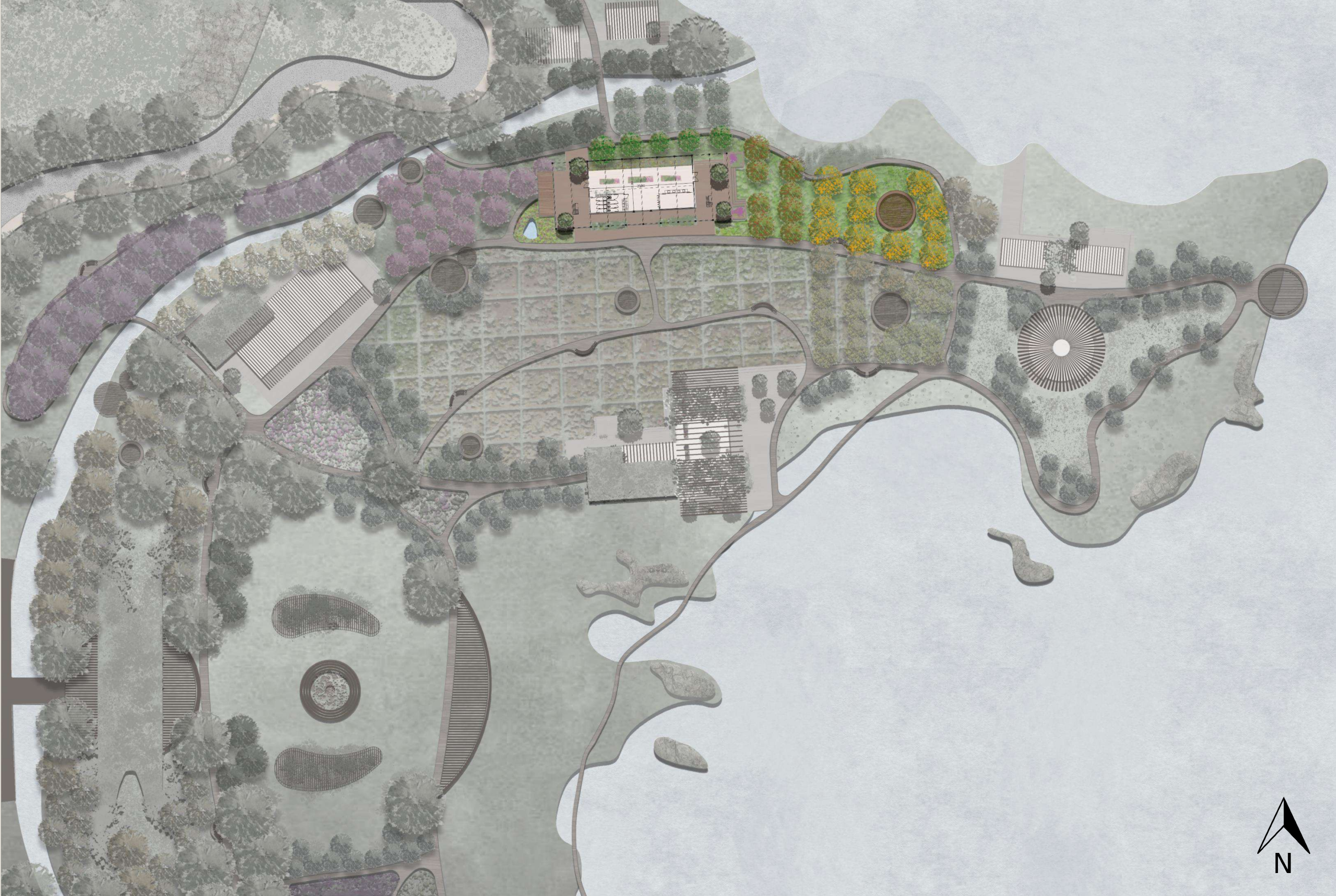

ESCALA ARQUITECTURA DEL PAISAJE



ESCALA ARQUITECTURA DEL PAISAJE

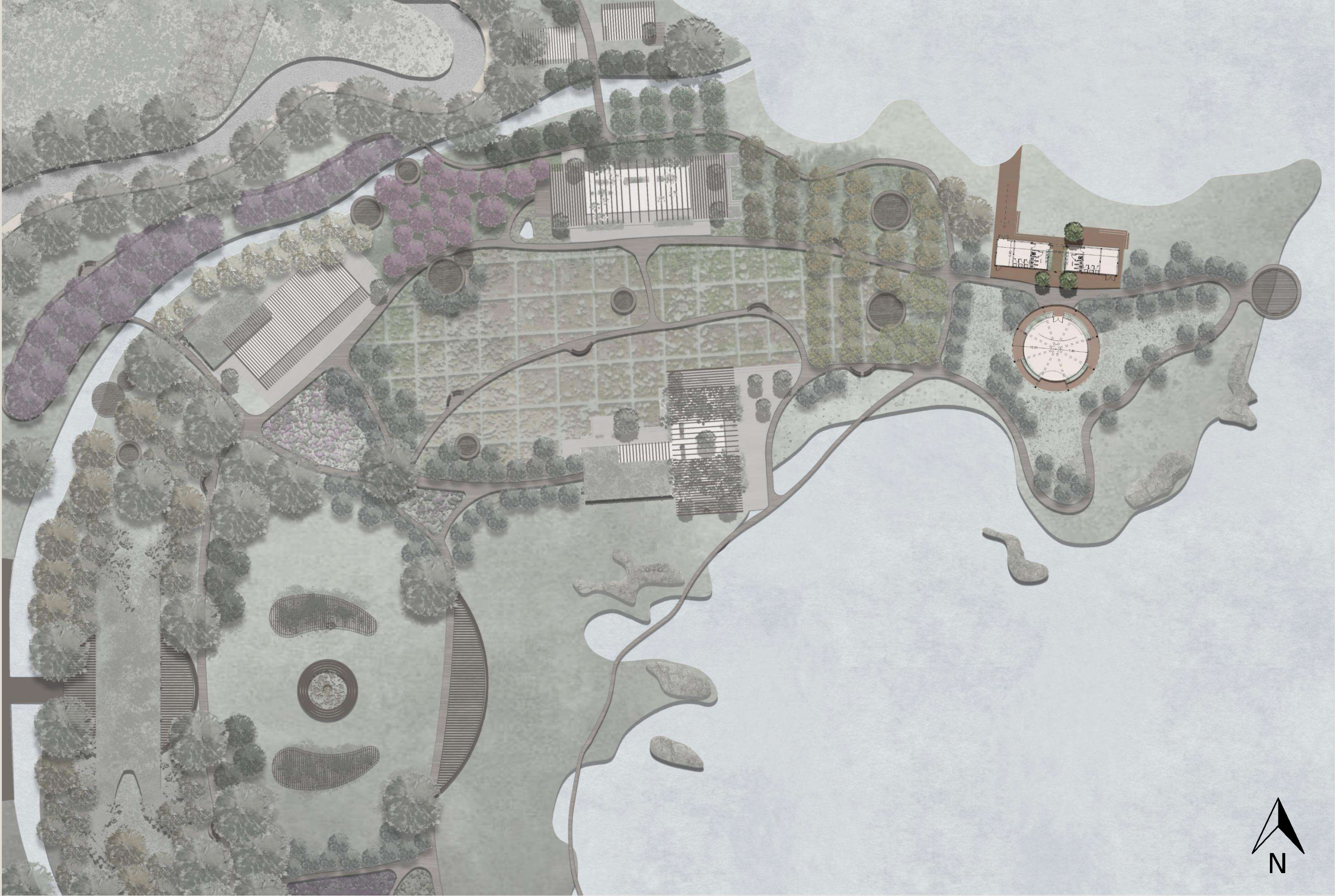

ESCALA ARQUITECTURA DEL PAISAJE





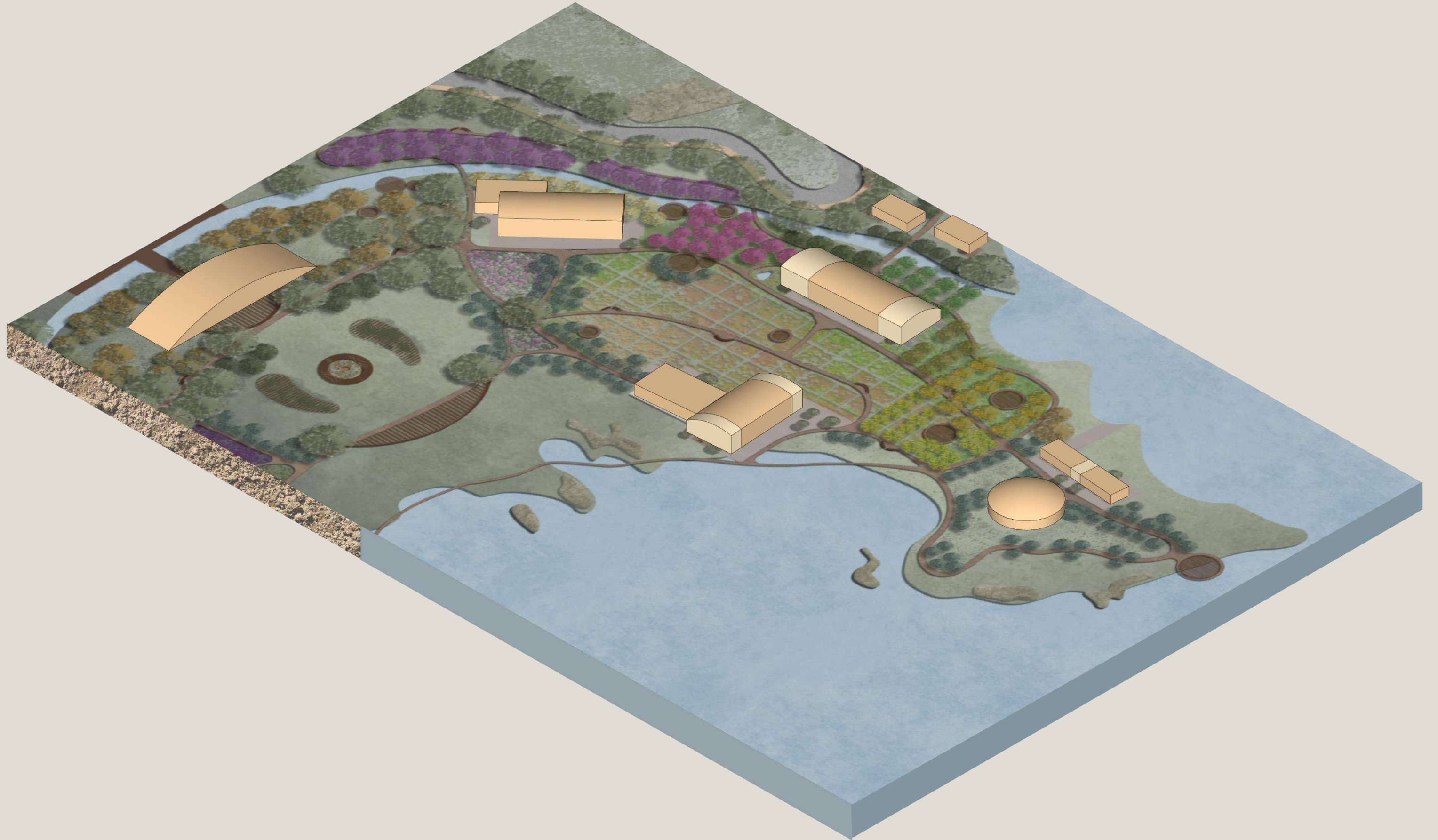

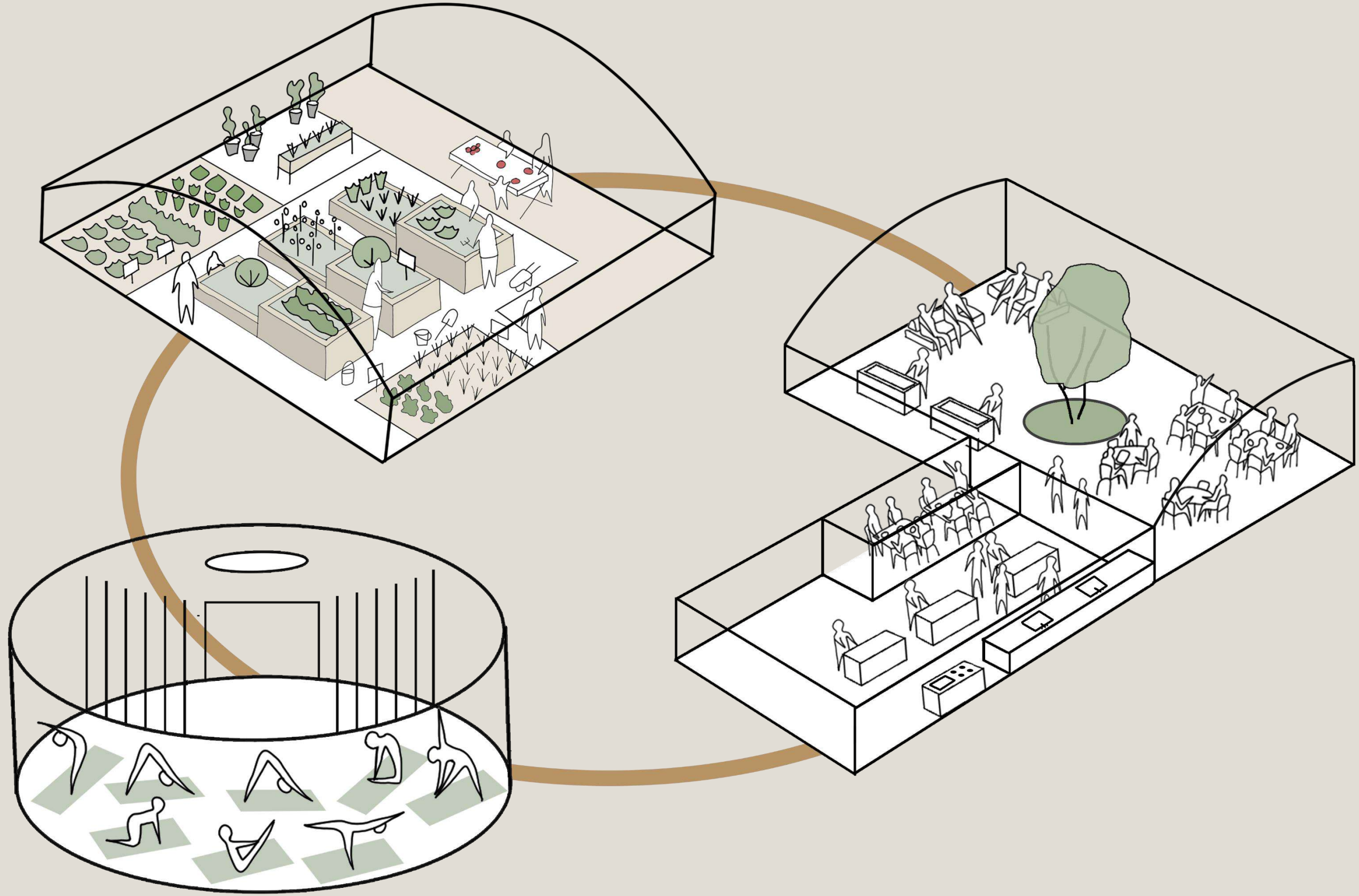





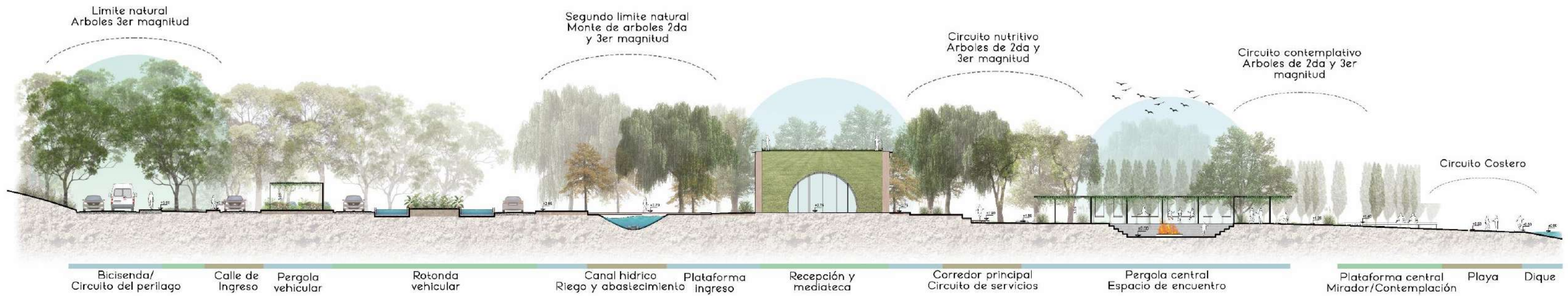

CORTE 1. 1:200 - tunel de platano - Ingreso - monte - vacio central - playa.



ZOOM 1: Eje movilidad sustentable
Tunel de platano



ZOOM 2: Edificio recepción
rodeado de monte (Arboles mixtos)

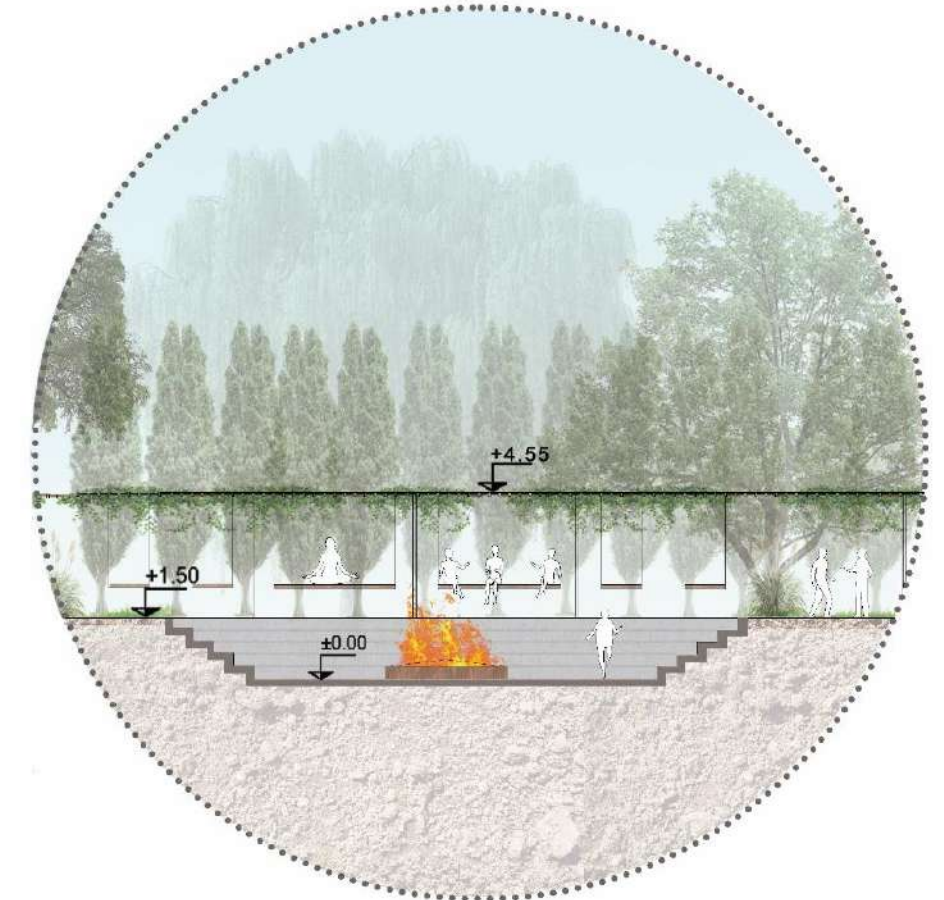

ZOOM 3: Vacio central - punto de encuentro
Pergola, anfiteatro y fogon



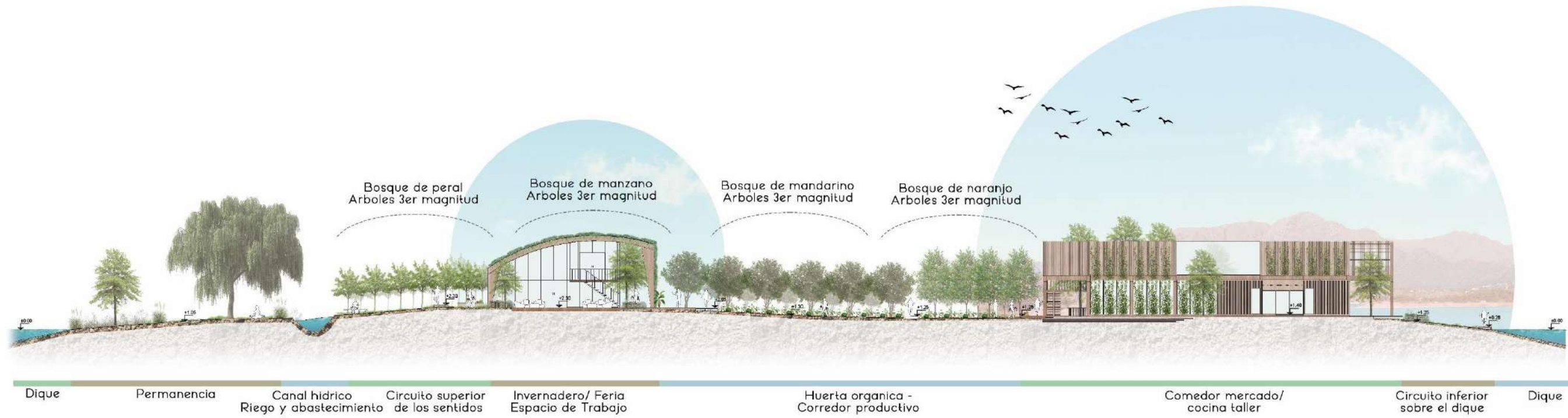

CORTE VISTA 2. 1:200 - Canal - invernadero - huertas - frutales - comedor/mercado.



ZOOM 3: Corte Invernadero rodeado de huerta y frutales



ZOOM 4: Corte comedor/mercado





VISTA 3. 1:100 - Sum para actividades grupales y modelo de servicios y deposito



CORTE 3. 1:100 - Sum para actividades grupales y modelo de servicios y deposito

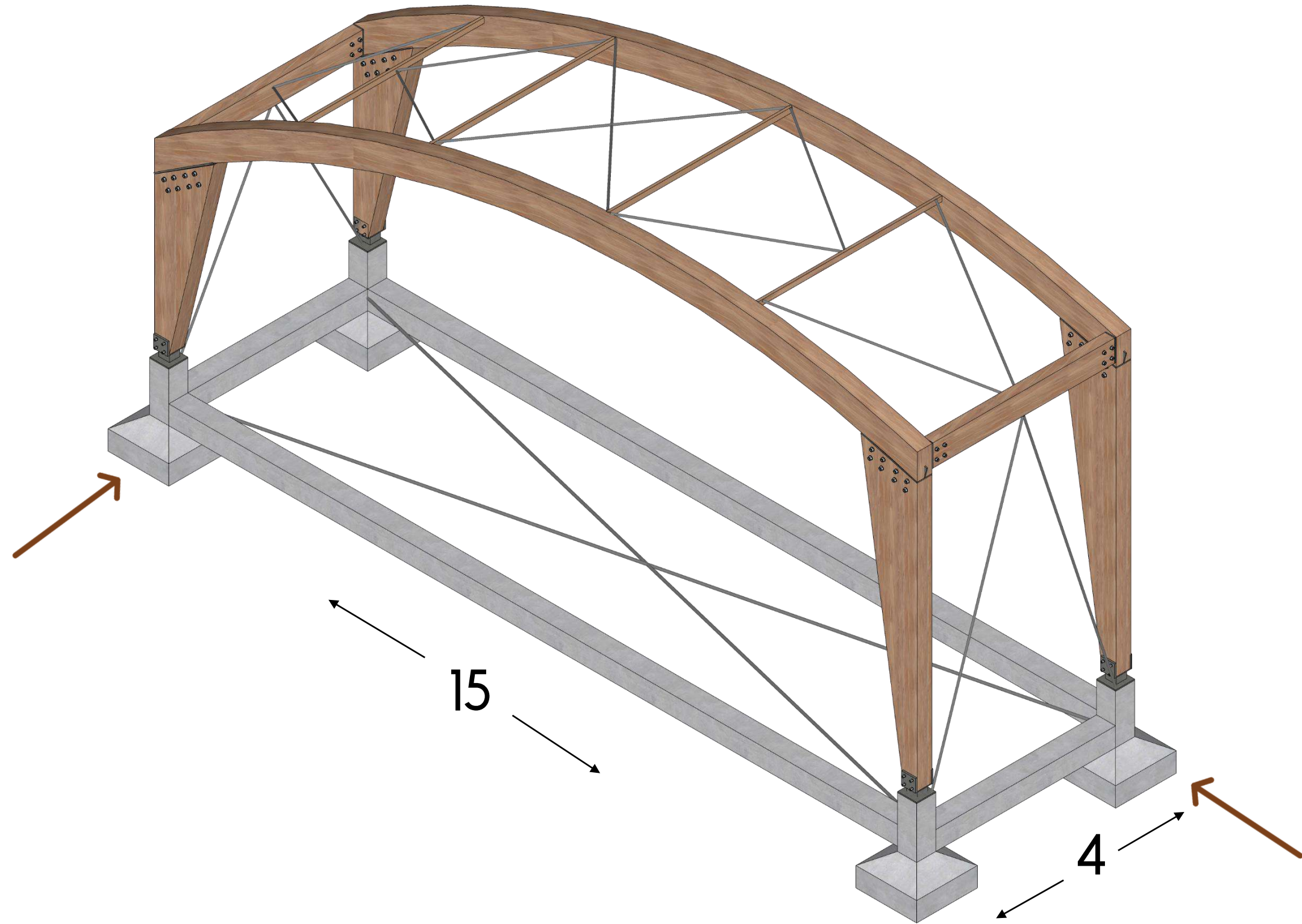

INGRESO A LA ALDEA



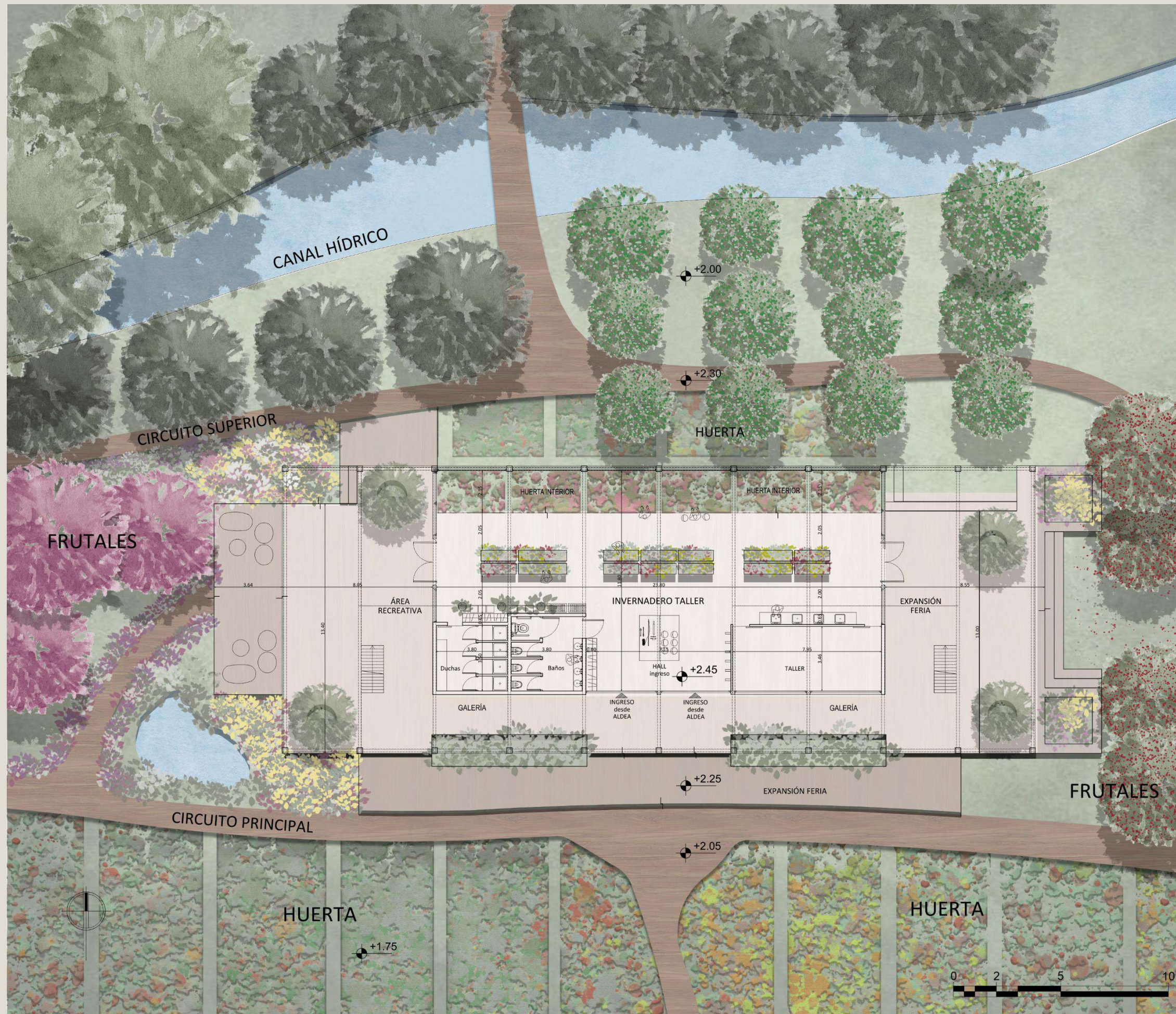

INTERIOR INVERNADERO



EXTERIOR INVERNADERO



FACHADA INVERNADERO



PÉRGOLA ENTRE FRUTALES



ATMOSFERAS DE TRATAMIENTO





INTERIOR COMEDOR



INTERIOR COMEDOR



EXTERIOR COMEDOR



COCINA TALLER



SECTOR DE HUERTA Y QUINCHO



BAÑOS



CALIDEZ Y PERTENENCIA



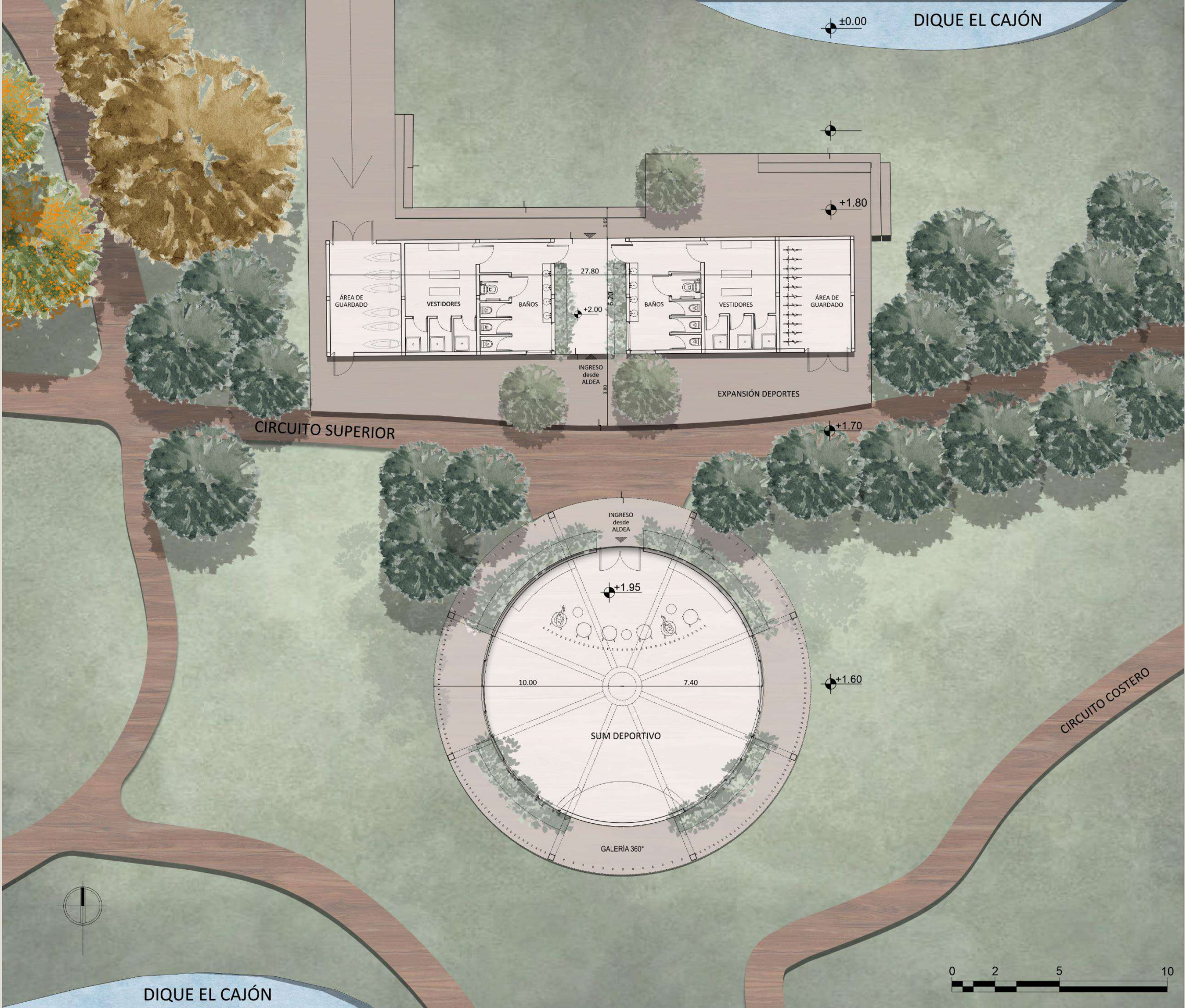

EXTERIOR SUM ACTIVIDADES GRUPALES



INTERIOR SUM ACTIVIDADES GRUPALES





PROPUESTA NODO INTERMEDIO

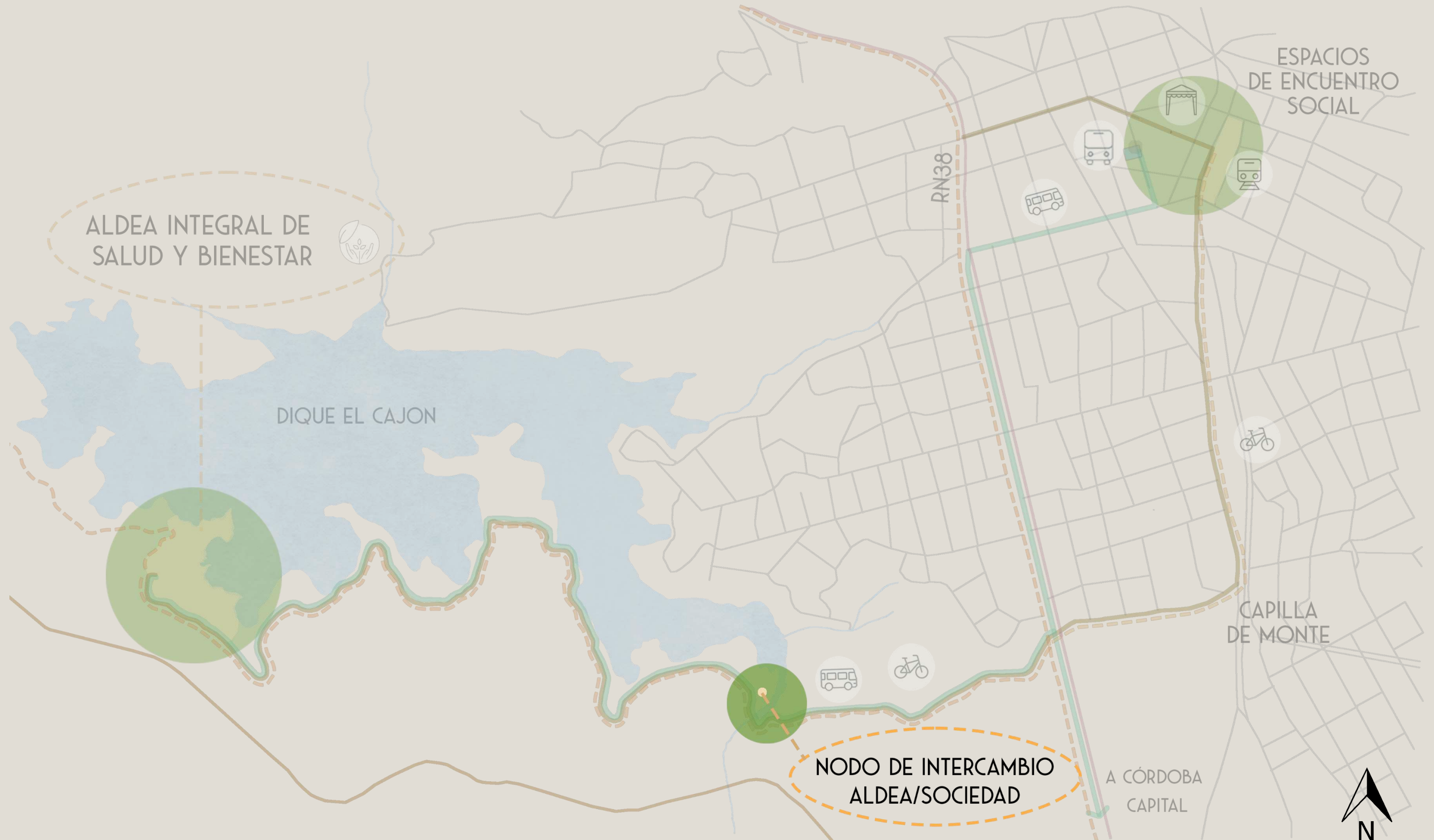

FERIA NODO INTERMEDIO











GRACIAS POR LA ATENCIÓN Y
POR ACOMPAÑARNOS!



CATEDRA DE TESIS
ARQUITECTURA VIC

Prof. Titular: MULLINS, Patricio
Prof. Adjuntas: COLAUTTI, Viviana
ARAUJO ALBRECHT, Laura
Prof. Asist: ARAUJO ALBRECHT, Laura



Universidad
Nacional
de Córdoba